

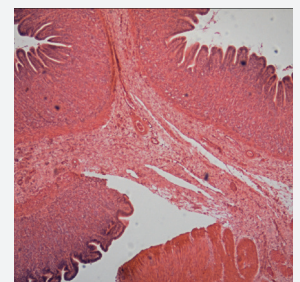

Invenio SIII Camera

- ▶ High-resolution
- ▶ Plug and Play
- ▶ High-speed live video
- ▶ Cost effective

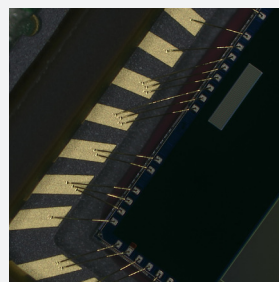
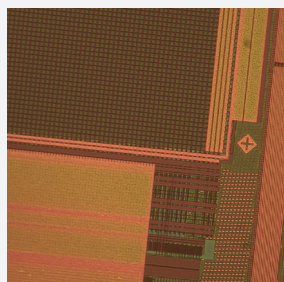
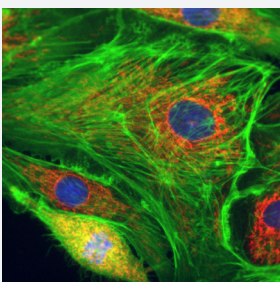

Camera Models

Capture sharp and vivid images for everyday analysis and documentation with the Invenio SIII color camera series. Invenio SIII series is designed as a multipurpose, simple and affordable solution that simplifies the imaging process from capture through to image handling.



High-quality, cost-effective and flexible

All DeltaPix microscope cameras has C-mount interface making them easily and cost efficiently fitted on most standard microscopes.



User-friendly Camera

Plug and play – the USB 3.0 interface provides high speed and ease of installation on any computer.

No need for external power supply, the Invenio SIII Microscope cameras uses the included USB cable for power, control and to data transmission.



Applications

Typical applications: ✓ Documentation and publishing ✓ Material science ✓ Metrology ✓ Quality control ✓ Dark Field ✓ Bright Field ✓ Semiconductor inspection ✓ Biology

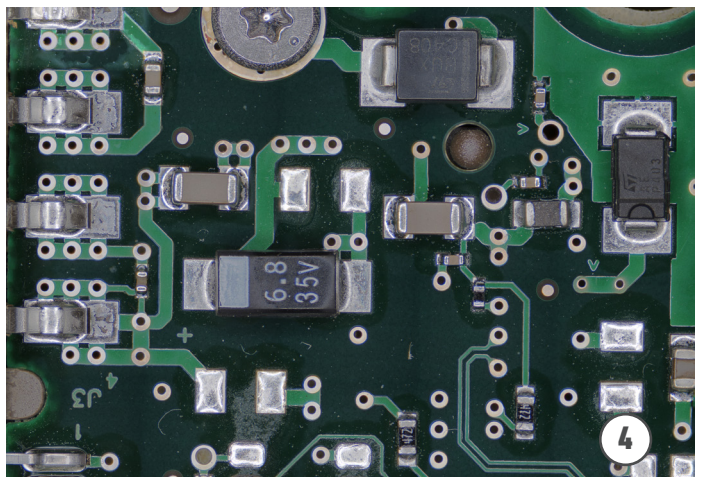
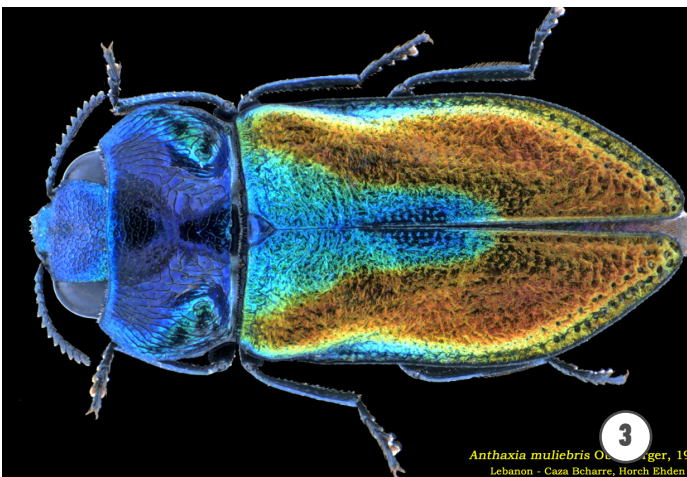
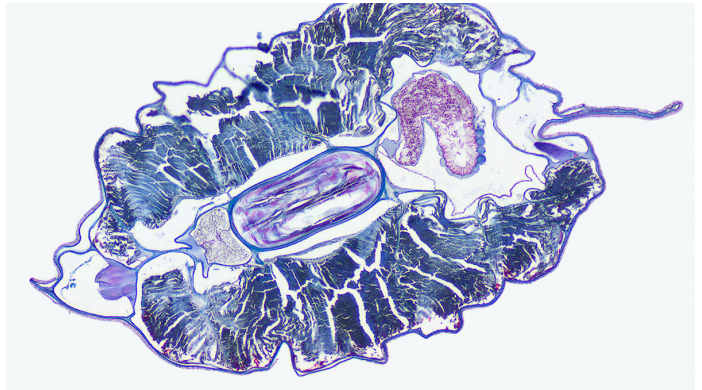

Why choose DeltaPix Invenio SIII camera?

Camera construction

There is a huge difference between so called “machine vision cameras” and cameras designed and build for microscopy. In most Machine vision applications, “details” as colors, hot pixels, dust particles, user friendliness and likewise, does not matter much, as it’s a machine which are looking at the images/video stream. For a dedicated microscope camera all these details matters a lot. Firstly, a microscope camera is typically physically larger in order to adapt more heat, keeping the sensor cool. The IR filter is of higher quality, free from small scratches and holes, which could create shadows in the image (DeltaPix inspects all filter and sensors surfaces carefully, a process which can last up to 2 hours. Around 20% of all filters are discarded during this process).

Also even extremely small dust particles can create dark shadows in the image of a camera used for microscopy. For this reason, all DeltaPix microscope cameras are manufactured by DeltaPix in a dust free clean chamber to achieve unmatched clear, sharp and crisp images. dynamic range and contrast known from traditional CMOS sensors.

Camera Design

Noise comes from the sensor itself, but also from the surrounding electronic circuits and the wires. By choosing components, wiring, grounding and shielding intelligently, DeltaPix has achieved to decrease noise levels significantly.

DeltaPix InSight Software

All Invenio EIII cameras Includes DeltaPix InSight which is a powerful platform for precise measurements and analysis.

DeltaPix InSight allows expansion with a multitude of modules, for a wide range of advanced applications with an easy-to-use user interface. Available modules, images stacking, HDR for wide dynamic images, 3D measurements/ 3D topography, Roughness measurement, stitching, Object Counting and much more.

Spectral Sensitivity

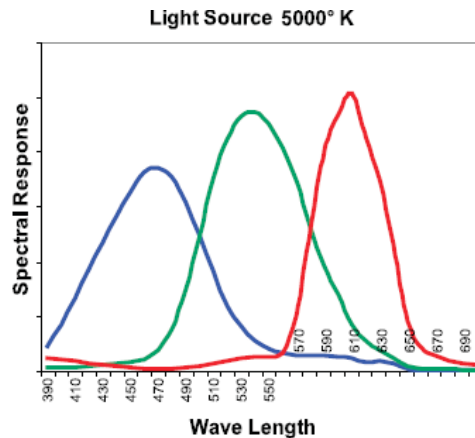

Camera Dimensions

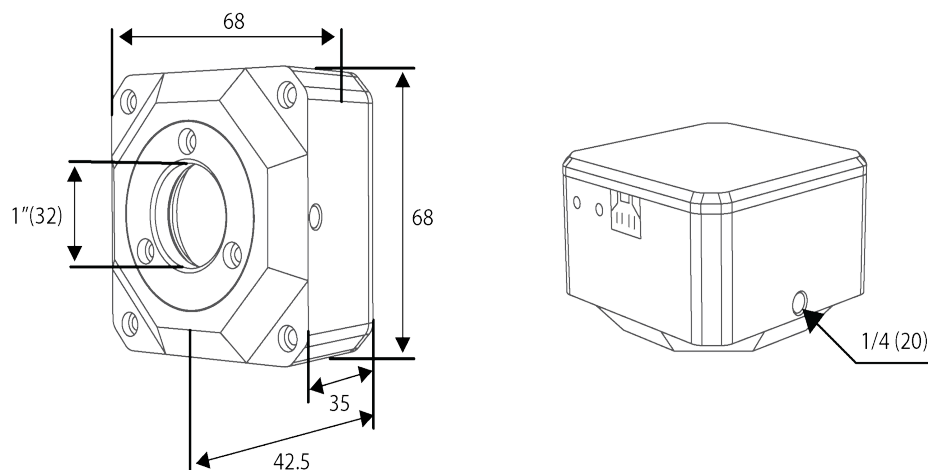

DeltaPix Invenio SIII Camera models

Features

	Invenio 5SIII	Invenio 10SIII
Live preview resolution	2592 X 1944 @14FPS 1280 X 960 @30FPS 640 X 480 @48FPS	3584 X 2746 @7FPS 1792 X 1372 @15FPS 896 X 480 @47FPS
Still image resolution	5 Mpixels (2592x1944) 1,2Mpixels (1280X960) 0,3Mpixels (640 X 480)	9,8 Mpixels 3584 X 2746 2,5 Mpixels 1792 X 1372 0,6 Mpixels 896 X 480
Sensor size	1/2.5" format CMOS 5.7 mm x 4.28 mm	1/2.3" format CMOS 5.98 mm x 4.58 mm
Pixel size	2,2µm x 2.2µm	1,67µm x 1.67µm
Exposure time	0,01ms - 2000ms	
Gain	1-3	
Sensitivity	1.76v/lux-sec	0.31v/lux-sec
Dynamic Range	67.74dB	65.2dB
Signal to noise	38 dB	34dB
Shutter	Electronic rolling shutter	
Exposure mode	Automatic or Manual	
Color balance	Automatic, manual or spot white balance	
Data interface	USB 3.0	
Data format and compression	24-bit uncompressed Tiff, 24bit JPEG compressed and 24-bit loss-less compressed JPEG2000 24bit uncompressed video AVI format.	
Minimum requirements	Intel I5 (quad core) CPU 4 GB RAM 15 GB free hard disk space USB 3.0 port Windows 7,8 ,10 32bits and 64 bits	
Optional	Software Developer Kit (SDK) for developing deep integration with other software applications.	

DeltaPix Aps, Hassellunden 16,
DK-2765 Smorum Denmark
Telephone:+45 46760205
E-mail: deltapix@deltapix.dk